

DAIKIN ROOM AIR CONDITIONER

OPERATION MANUAL

INVERTER



MODELS

- FTXS25J2VMA
- FTXS35J2VMA

Feature

For your comfort and energy saving



INTELLIGENT EYE

The INTELLIGENT EYE sensor detects the human movement in a room. If nobody in the room for more than 20 minutes, the operation automatically changes to energy saving operation.

▶Page 15



WEEKLY TIMER

Up to 4 timer settings can be saved for each day of the week according to your family's life style. The WEEKLY TIMER allows you to set on/off time and the desired temperature.

▶Page 22

Other function



COMFORT AIRFLOW

The airflow direction will be in upward while cool operation, in downward while in heat operation. This function will prevent cold or warm air from directly blowing on your body.

▶Page 15



OUTDOOR UNIT QUIET

OUTDOOR UNIT QUIET operation lowers the noise level of the outdoor unit. This function is useful when you need to consider for your neighborhood.









▶Page 18

Contents

■ Read before Operation

Safety Precautions	3
Name of Parts	5
Preparation before Operation	9

■ Operation

 AUTO · DRY · COOL · HEAT · FAN Operation	11
 Adjusting the Airflow Direction and Rate	13
 COMFORT AIRFLOW / INTELLIGENT EYE Operation	15
 POWERFUL Operation	17
 OUTDOOR UNIT QUIET Operation	18
 ECONO Operation	19
 OFF TIMER Operation	20
 ON TIMER Operation	21
 WEEKLY TIMER Operation	22

■ Multi Connection

Note for Multi System	28
-----------------------------	----

■ Care

Care and Cleaning	30
-------------------------	----

■ Troubleshooting

Troubleshooting	35
-----------------------	----





ECONO





This function enables efficient operation by limiting the maximum power consumption. It is useful when using the air conditioner and other electrical devices simultaneously.

▶ Page 19

Safety Precautions



- Keep this manual where the operator can easily find them.
- Read the precautions in this manual carefully before operating the unit.
- The precautions described herein are classified as **WARNING** and **CAUTION**. They both contain important information regarding safety. Be sure to observe all precautions without fail.

 WARNING	 CAUTION
Failure to follow these instructions properly may result in personal injury or loss of life.	Failure to observe these instructions properly may result in property damage or personal injury, which may be serious depending on the circumstances.

 Never attempt.	 Never wet the air conditioner nor the remote controller with water.
 Be sure to follow the instructions.	 Never touch the air conditioner nor the remote controller with wet hands.
 Be sure to establish an earth connection.	

- After reading, keep this manual in a convenient place so that you can refer to it whenever necessary. If the equipment is transferred to a new user, be sure also to hand over the manual.

WARNING

-  In order to avoid fire, explosion or injury, do not operate the unit when harmful, among which flammable or corrosive gases, are detected near the unit.
 - Be aware that prolonged, direct exposure to cool or warm air from the air conditioner, or to air that is too cool or too warm can be harmful to your physical condition and health.
 - Do not place objects, including rods, your fingers, etc., in the air inlet or outlet. Product malfunctioning, product or injury damage may result due to contact with the air conditioner's high-speed fan blades.
 - Do not attempt to repair, dismantle reinstall or modify the air conditioner yourself as this may result in water leakage, electric shocks or fire hazards.
 - Do not use flammable spray near the air conditioner, or otherwise fire may result.
-
-  Beware of fire in case of refrigerant leakage. If the air conditioner is not operating correctly, i.e. not generating cool or warm air, refrigerant leakage could be the cause. Consult your dealer for assistance. The refrigerant within the air conditioner is safe and normally does not leak. However, in the event of a leakage, contact with a naked burner, heater or cooker may result in generation of noxious gas. Do not longer use the air conditioner until a qualified service person confirms that the leakage has been repaired.
 - Do not attempt to install or repair the air conditioner yourself. Improper workmanship may result in water leakage, electric shocks or fire hazards. Please contact your local dealer or qualified personnel for installation and maintenance work.
 - When the air conditioner is malfunctioning (giving off a burning odour, etc.) turn off power to the unit and contact your local dealer. Continued operation under such circumstances may result in a failure, electric shocks or fire hazards.
 - Be sure to install an earth leakage breaker. Failure to install an earth leakage breaker may result in electric shocks or fire.
-
-  Be sure to earth the unit. Do not earth the unit to a utility pipe, lightning conductor or telephone earth lead. Imperfect earthing may result in electric shocks.

CAUTION

-  Do not use the air conditioner for purposes other than those for which it is intended. Do not use the air conditioner for cooling precision instruments, food, plants, animals or works of art as this may adversely affect the performance, quality and/or longevity of the object concerned.
- Do not expose plants or animals directly to airflow from the unit as this may cause adverse effects.
- Do not place appliances that produce naked flames in places exposed to the airflow from the unit as this may impair combustion of the burner.



CAUTION



- Do not block air inlets nor outlets. Impaired airflow may result in insufficient performance or trouble.
- Do not sit on the outdoor unit, put things on the unit, or pull the unit. Doing so may cause accidents, such as falling or toppling down, thus resulting in injury, product malfunctioning, or product damage.
- Do not place objects that are susceptible to moisture directly beneath the indoor or outdoor units. Under certain conditions, condensation on the main unit or refrigerant pipes, air filter dirt or drain blockage may cause dripping, resulting in fouling or failure of the object concerned.
- After prolonged use, check the unit stand and its mounts for damage. If left in a damaged condition, the unit may fall and cause injury.
- To avoid injury, do not touch the air inlet or aluminium fins of the indoor or outdoor units.
- The appliance is not intended for use by unattended young children or infirm persons. Impairment of bodily functions and harm to health may result.
- Children should be supervised to ensure that they do not play with the unit or its remote controller. Accidental operation by a child may result in impairment of bodily functions and harm health.
- Do not give impact to the indoor and outdoor units, or otherwise product damage may result.
- Do not place flammable items, such as spray cans, within 1 meter of the air outlet.
The spray cans may explode as a result of hot air from the indoor or outdoor units.
- Be careful not to let pets urinate on the air conditioner. Urination on the air conditioner may result in electric shocks or fire.



- To avoid oxygen depletion, ensure that the room is adequately ventilated if equipment such as a burner is used together with the air conditioner.
- Before cleaning, be sure to stop unit operation, turn the breaker off or remove the power cord. Otherwise, an electric shock and injury may result.
- Only connect the air conditioner to the specified power supply circuit. Power supplies other than the one specified may result in electric shocks, overheating and fires.
- Arrange the drain hose to ensure smooth drainage. Imperfect drainage may cause wetting of the building, furniture etc.
- Do not place objects in direct proximity of the outdoor unit and do not let leaves and other debris accumulate around the unit. Leaves are a hotbed for small animals which can enter the unit. Once in the unit, such animals can cause malfunctions, smoke or fire when making contact with electrical parts.
- Do not place objects around the indoor unit.
Doing so may have an adverse influence on the performance, product quality, and life of the air conditioner.



- To avoid electric shocks, do not operate with wet hands.



- Do not wash the air conditioner with water, as this may result in electric shocks or fire.
- Do not place water containers (flower etc.) above the unit, as this may result in electric shocks or fire hazards.

Installation site.

- To install the air conditioner in the following types of environments, consult the dealer.
 - Places with an oily ambient or where steam or soot occurs.
 - Salty environment such as coastal areas.
 - Places where sulfide gas occurs such as hot springs.
 - Places where snow may block the outdoor unit.
 - The indoor unit is at least 1 meter away from any television or radio set (unit may cause interference with the picture or sound).
 - The drain from the outdoor unit must be discharged to a place of good drainage.

Consider nuisance to your neighbours from noises.

- For installation, choose a place as described below.
 - A place solid enough to bear the weight of the unit which does not amplify the operation noise or vibration.
 - A place from where the air discharged from the outdoor unit or the operation noise will not annoy your neighbours.

Electrical work.

- For power supply, be sure to use a separate power circuit dedicated to the air conditioner.

System relocation.

- Relocating the air conditioner requires specialized knowledge and skills. Please consult the dealer if relocation is necessary for moving or remodeling.

Name of Parts

Indoor Unit

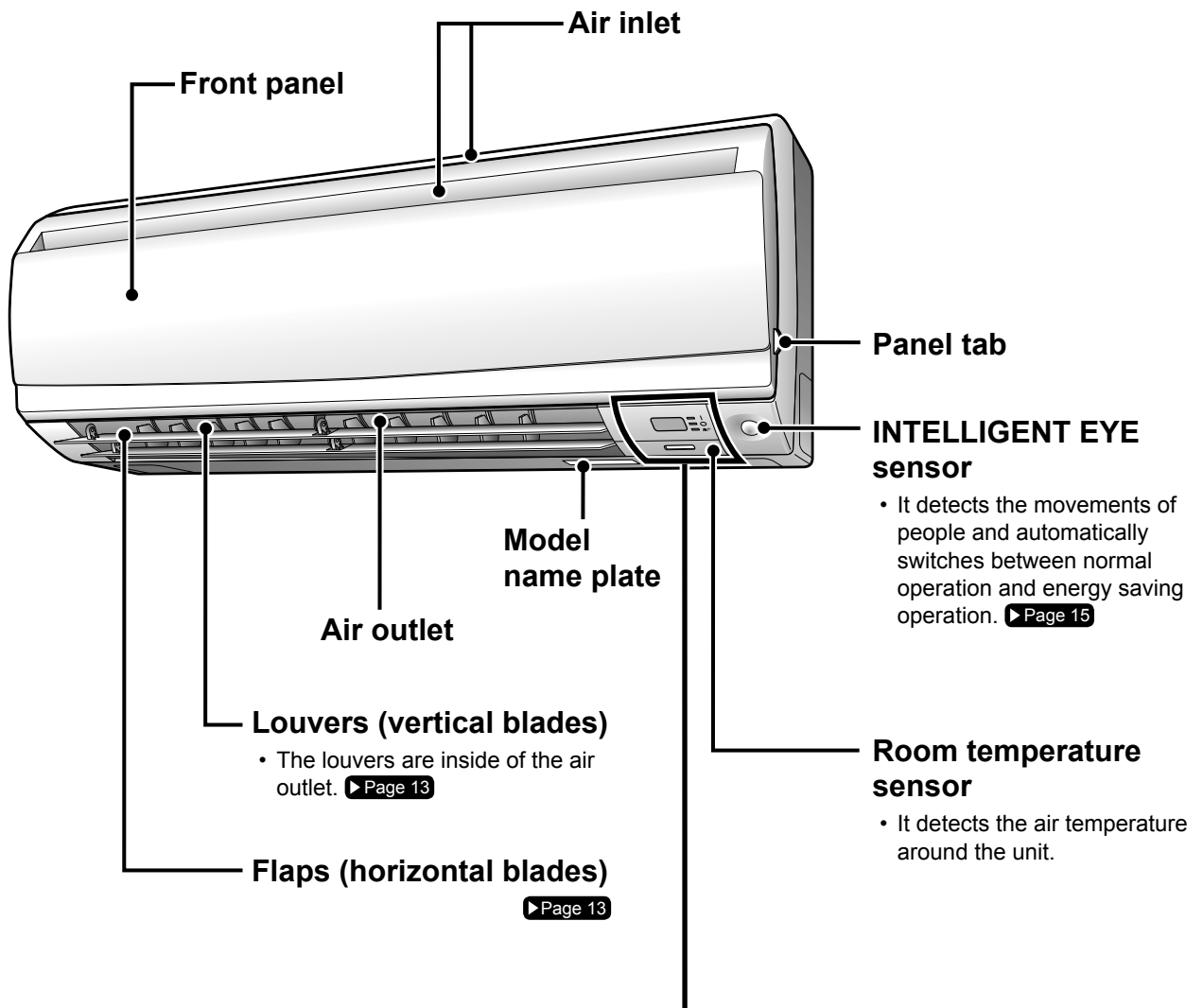

Display

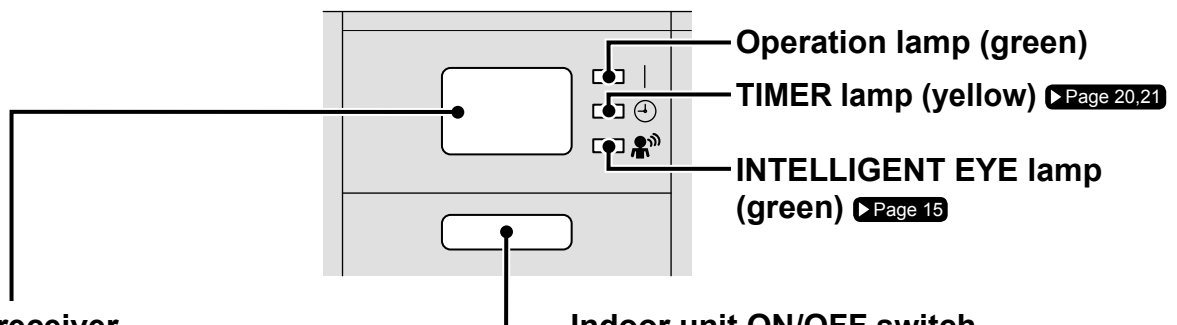

Signal receiver

- It receives signals from the remote controller.
- When the unit receives a signal, you will hear a beep sound.

Case	Sound type
Operation start	beep-beep
Setting changed	beep
Operation stop	long beep

Indoor unit ON/OFF switch

- Press this switch once to start operation. Press once again to stop it.
- The operation mode refer to the following table.

Mode	Temperature setting	Airflow rate
AUTO	25°C	AUTO

- This switch is useful when the remote controller is missing.

■ Open the front panel

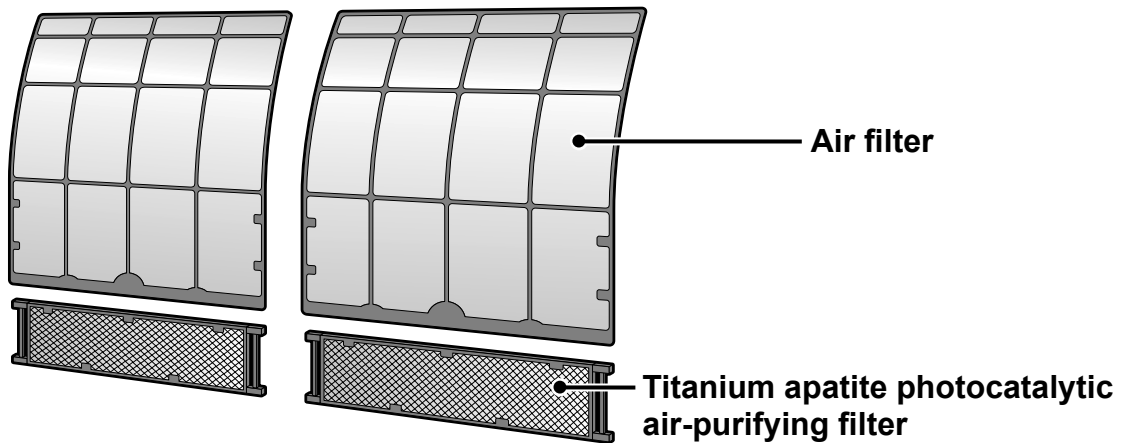
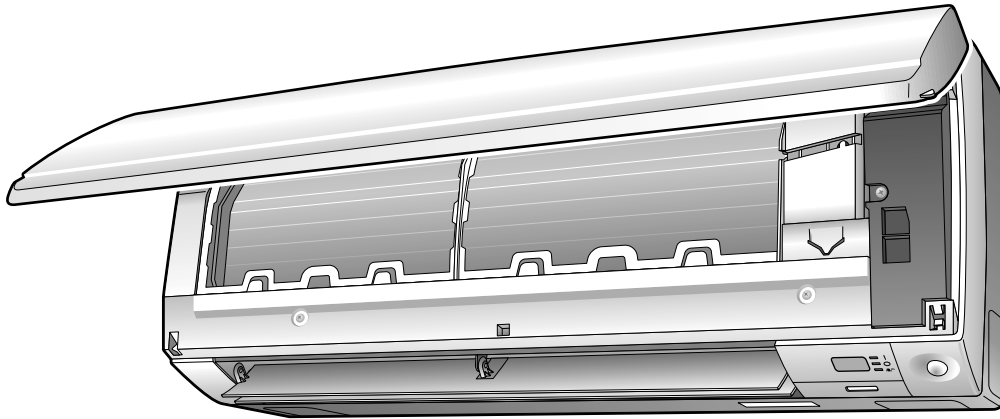

Outdoor Unit

- Appearance of the outdoor unit may differ from some models.

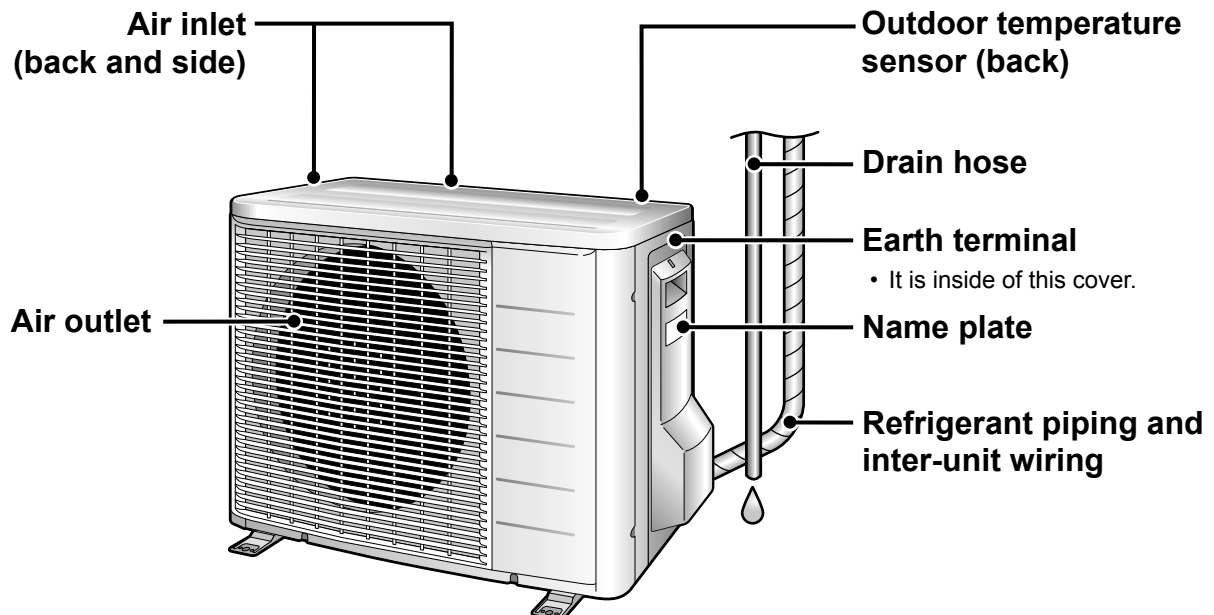

Name of Parts

Remote Controller

Signal transmitter

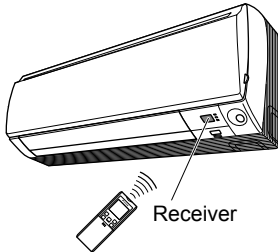

- To use the remote controller, aim the transmitter at the indoor unit. If there is anything to block signals between the unit and the remote controller, such as a curtain, the unit will not operate.
- Do not drop the remote controller. Do not get it wet.
- The maximum distance for communication is approx. 7m.

FAN setting button

- It selects the airflow rate setting.

▶ Page 14

POWERFUL button

- POWERFUL operation. ▶ Page 17

Display (LCD)

- It displays the current settings. (In this illustration, each section is shown with all its displays on for the purpose of explanation.)

TEMPERATURE adjustment buttons

- It changes the temperature setting.

▶ Page 12

ON/OFF button

- Press this button once to start operation.

Press once again to stop it. ▶ Page 11

Front cover

- Open the front cover. ▶ Page 8

Model: ARC452A4

■ Open the front cover



MODE selector button

- It selects the operation mode. (AUTO/DRY/COOL/HEAT/FAN) ▶Page 11

ECONO button

- ECONO operation. ▶Page 19

QUIET button

- OUTDOOR UNIT QUIET operation. ▶Page 18

SWING button

- Adjusting the airflow direction. ▶Page 13

COMFORT/SENSOR button

- COMFORT AIRFLOW and INTELLIGENT EYE operation. ▶Page 15,16

WEEKLY : WEEKLY button

PROGRAM button

COPY : COPY button

BACK : BACK button

NEXT : NEXT button

- WEEKLY TIMER operation. ▶Page 22

OFF TIMER button

▶Page 20

ON TIMER button

▶Page 21

TIMER CANCEL button

- It cancels the timer setting. ▶Page 20,21
- It cannot be used for the WEEKLY TIMER operation.

CLOCK button ▶Page 10

SELECT button

- It changes the ON/OFF TIMER and WEEKLY TIMER settings. ▶Page 20,21,22

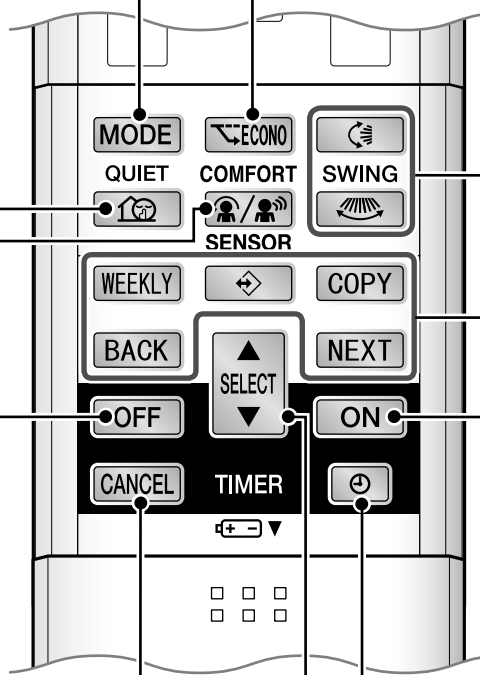

Preparation before Operation

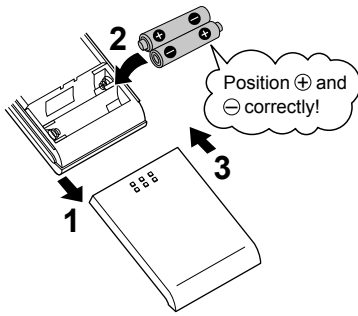

■ To set the batteries

- 1. Slide the front cover to take it off.**
- 2. Set 2 dry batteries AAA.LR03 (alkaline).**
- 3. Set the front cover as before.**

■ To fix the remote controller holder on the wall

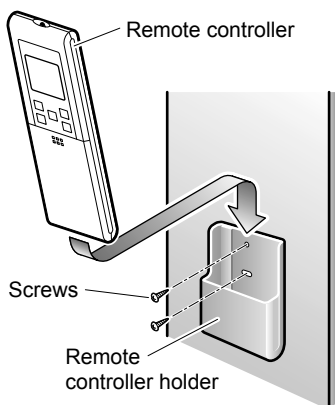

- 1. Choose a place from where the signals reach the unit.**
- 2. Fix the holder to a wall, a pillar, etc. with the screws supplied with the holder.**
- 3. Place the remote controller in the remote controller holder.**

NOTE

■ Notes on batteries

- When replacing the batteries, use batteries of the same type, and replace the 2 old batteries together.
- When the system is not used for a long time, take the batteries out.
- The batteries will last for approx. 1 year. If the remote controller display begins to fade and the degradation of reception performance occurs within a year, however, replace both 2 batteries with new, size AAA.LR03 (alkaline).
- The attached batteries are provided for the initial use of the system.
The usable period of the batteries may be short depending on the manufactured date of the air conditioner.

■ Notes on remote controller

- Never expose the remote controller to direct sunlight.
- Dust on the signal transmitter or receiver will reduce the sensitivity. Wipe off dust with soft cloth.
- Signal communication may be disabled if an electronic-starter-type fluorescent lamp (such as inverter-type lamps) is in the room. Consult the shop if that is the case.
- If the remote controller signals happen to operate another appliance, move that appliance to somewhere else, or consult the service shop.

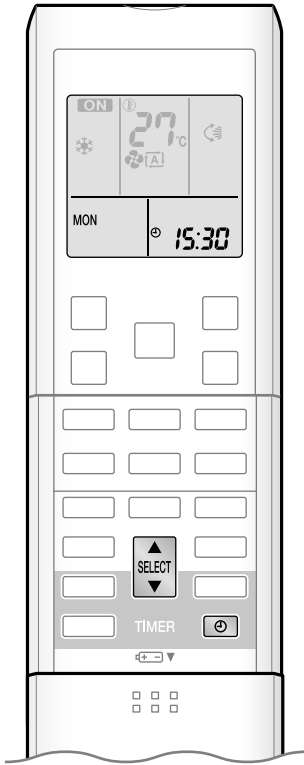

■ Turn the breaker on

- Turning on the breaker opens once and closes the flap. (This is a normal procedure.)

■ To set the clock

1. Press .

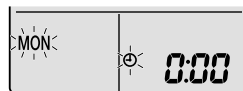

- "0:00" is displayed.
- "MON" and "⏻" blinks.

2. Press to set the current day of the week.

3. Press .



- "⏻" blinks.

4. Press to set the clock to the present time.

- Holding down ▲ or ▼ button rapidly increases or decreases the time display.

5. Press .

- Always point the remote controller at the indoor unit when pressing the buttons when setting the indoor unit's internal clock.



- "⏻" blinks.

NOTE

■ Note on setting the clock

- If the indoor unit's internal clock is not set to the correct time, the WEEKLY TIMER will not operate punctually.



AUTO · DRY · COOL · HEAT · FAN Operation

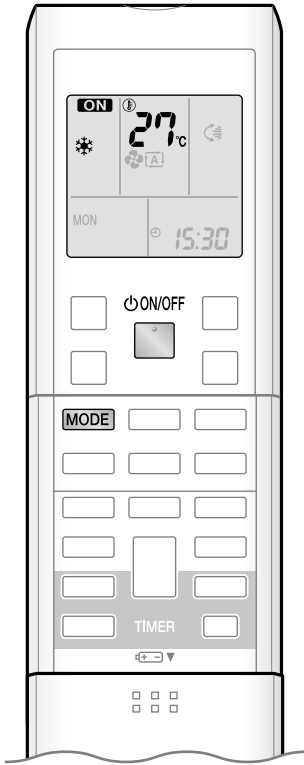

The air conditioner operates with the operation mode of your choice.
From the next time on, the air conditioner will operate with the same operation mode.

■ To start operation

1. Press **MODE** and select a operation mode.

- Each pressing of the button advances the mode setting in sequence.

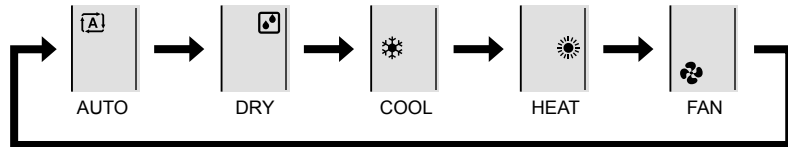

2. Press .

- “**ON**” is displayed on the LCD.
- The OPERATION lamp lights up.



Display

■ To stop operation

Press again.



- “**ON**” is disappears from the LCD.
- The OPERATION lamp goes off.

NOTE

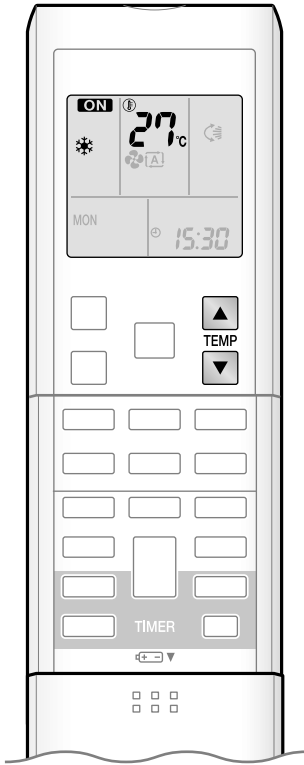
MODE	Notes on each operation mode
HEAT	<ul style="list-style-type: none"> • Since this air conditioner heats the room by taking heat from outdoor air to indoors, the heating capacity becomes smaller in lower outdoor temperatures. If the heating effect is insufficient, it is recommended to use another heating appliance in combination with the air conditioner. • The heat pump system heats the room by circulating hot air around all parts of the room. After the start of heating operation, it takes some time before the room gets warmer. • In heating operation, frost may occur on the outdoor unit and lower the heating capacity. In that case, the system switches into defrosting operation to take away the frost. • During defrosting operation, hot air does not flow out of indoor unit.
COOL	<ul style="list-style-type: none"> • This air conditioner cools the room by blowing the hot air in the room outside, so if the outside temperature is high, the performance of the air conditioner drops.
DRY	<ul style="list-style-type: none"> • The computer chip works to rid the room of humidity while maintaining the temperature as much as possible. It automatically controls temperature and airflow rate, so manual adjustment of these functions is unavailable.
AUTO	<ul style="list-style-type: none"> • In AUTO operation, the system selects a temperature setting and an appropriate operation mode (COOL or HEAT) based on the room temperature at the start of the operation. • The system automatically reselects setting at a regular interval to bring the room temperature to user-setting level.
FAN	<ul style="list-style-type: none"> • This mode is valid for fan only.



■ To change the temperature setting

Press  or .

- The displayed items on the LCD will change whenever either one of the buttons is pressed.

COOL mode	HEAT mode	AUTO mode	DRY or FAN mode
18 – 32°C	10 – 30°C	18 – 30°C	The temperature setting is not variable.
Press ▲ to raise the temperature and press ▼ to lower the temperature.			

■ Operating conditions

■ Recommended temperature setting

- For cooling: 26°C – 28°C
- For heating: 20°C – 24°C

■ Tips for saving energy

- Be careful not to cool (heat) the room too much.
Keeping the temperature setting at a moderate level helps save energy.
- Cover windows with a blind or a curtain.
Blocking sunlight and air from outdoors increases the cooling (heating) effect.
- Clogged air filters cause inefficient operation and waste energy. Clean them once in about every 2 weeks.

■ Notes on the operating conditions

- The air conditioner always consumes 15-35W of electricity even while it is not operating.
- If you are not going to use the air conditioner for a long period, for example in spring or autumn, turn the breaker off.
- Use the air conditioner in the following conditions.

MODE	Operating conditions	If operation is continued out of this range
COOL	Outdoor temperature : 10 to 46°C Indoor temperature : 18 to 32°C Indoor humidity : 80% max.	<ul style="list-style-type: none"> • A safety device may work to stop the operation. (In multi system, it may work to stop the operation of the outdoor unit only.) • Condensation may occur on the indoor unit and drip.
HEAT	Outdoor temperature : -15 to 24°C Indoor temperature : 10 to 30°C	<ul style="list-style-type: none"> • A safety device may work to stop the operation.
DRY	Outdoor temperature : 10 to 46°C Indoor temperature : 18 to 32°C Indoor humidity : 80% max.	<ul style="list-style-type: none"> • A safety device may work to stop the operation. • Condensation may occur on the indoor unit and drip.

- Operation outside this humidity or temperature range may cause a safety device to disable the system.



Adjusting the Airflow Direction and Rate

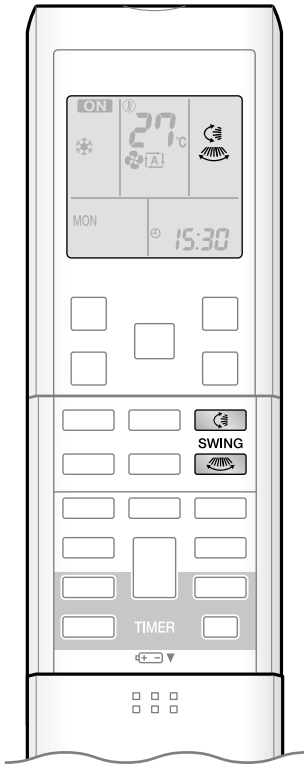

You can adjust the airflow direction to increase your comfort.

■ To start auto swing

Upper and lower airflow direction

Press .

- “” is displayed on the LCD.
- The flaps (horizontal blades) will begin to swing.

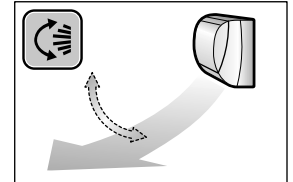

Right and left airflow direction



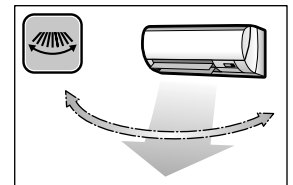

Press .

- “” is displayed on the LCD.
- The louvers (vertical blades) will begin to swing.



The 3-D airflow direction

Press  and .

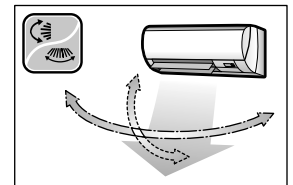

- “” and “” are displayed on the LCD.
- The flaps and louvers move in turn.
- To cancel 3-D airflow, press either  or  again. The flaps or louvers will stop moving.



■ To set the flaps or louvers at desired position

- This function is effective while flaps or louvers are in auto swing mode.

Press  and  when the flaps or louvers have reached the desired position.

- In the 3-D airflow, the flaps and louvers move in turn.
- “” or “” disappears from the LCD.

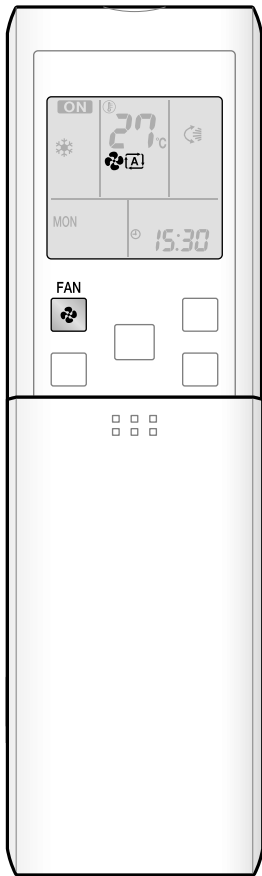

■ To adjust the airflow rate setting

Press .

- Each pressing of  advances the airflow rate setting in sequence.

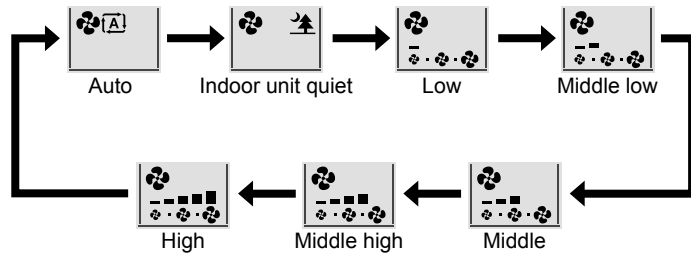

- When the airflow is set to “”, indoor unit quiet operation will start and the noise from the unit will become quieter.
- In indoor unit quiet operation, the airflow rate is set to a weak level.
- In DRY mode, the airflow rate setting is not variable.

NOTE

■ Note on the angles of the flaps

- The flaps swinging range depends on the operation mode. (See the figure.)

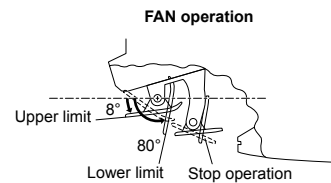
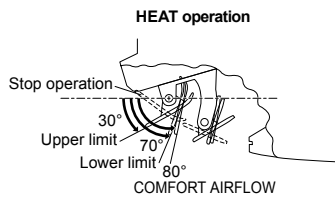
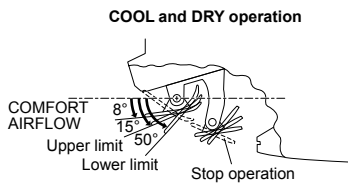

■ Note on 3-D airflow

- Using 3-D airflow circulates cold air, which tends to collect at the bottom of the room, and hot air, which tends to collect near the ceiling, throughout the room, preventing areas of cold and hot developing.

■ Note on airflow rate setting

- At smaller airflow rates, the cooling (heating) effect is also smaller.

⚠ CAUTION

- Always use a remote controller to adjust the angles of the flaps and louvers. If you attempt to move it forcibly with hand when it is swinging, the mechanism may be broken.
- Always use a remote controller to adjust the louvers angles. Inside the air outlet, a fan is rotating at a high speed.



COMFORT AIRFLOW / INTELLIGENT EYE Operation

COMFORT AIRFLOW operation

The flow of air will be in the upward direction while in COOL operation and in the downward direction while in HEAT operation, which will provide a comfortable wind that will not come in direct contact with people.

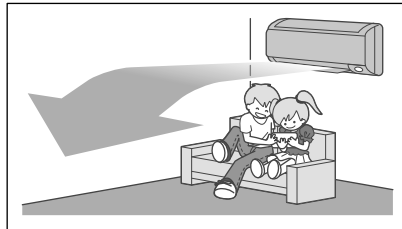

COOL operation

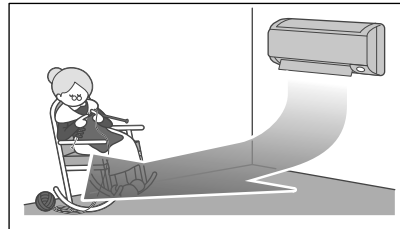

HEAT operation

INTELLIGENT EYE operation

“INTELLIGENT EYE” is the infrared sensor which detects the human movement.

If nobody in the room for more than 20 minutes, the operation automatically changes to energy saving operation.

[Example]

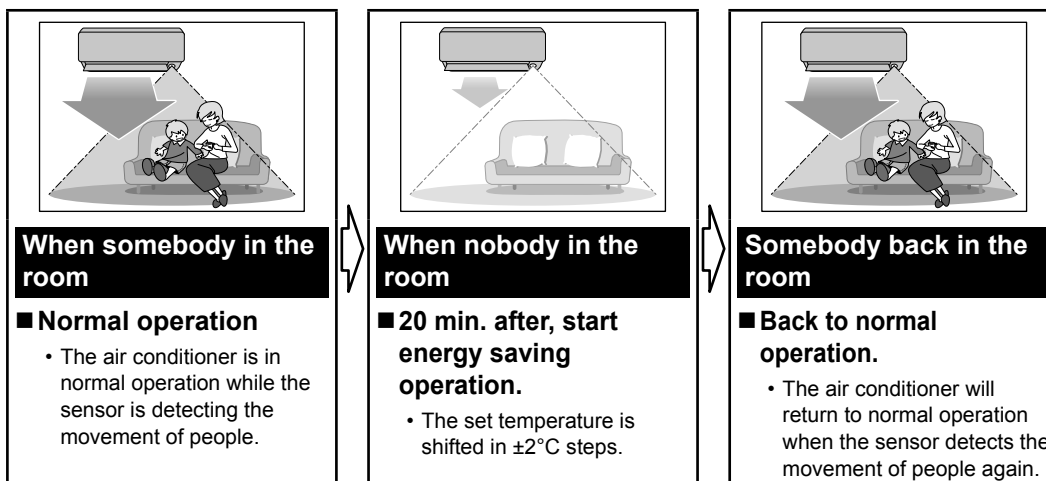

INTELLIGENT EYE operation is useful for energy saving

Energy saving operation

- If no presence detected in the room for 20 minutes, the energy saving operation will start.
- This operation changes the temperature -2°C in HEAT / $+2^{\circ}\text{C}$ in COOL / $+2^{\circ}\text{C}$ in DRY mode from set temperature.
- This operation decreases the airflow rate slightly in FAN mode only.

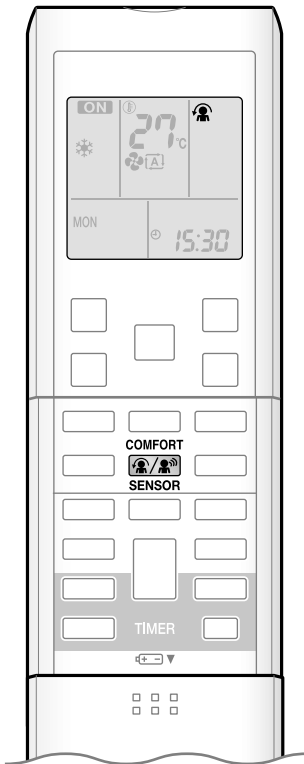

Combination COMFORT AIRFLOW and INTELLIGENT EYE operation

The air conditioner can go into operation with the COMFORT AIRFLOW and INTELLIGENT EYE functions combined.



■ To start operation

Press  and select the desired mode.

- Each time the  is pressed a different setting option is displayed on the LCD.
- By selecting “ ” from the following icons, the air conditioner will be in COMFORT AIRFLOW operation combined with INTELLIGENT EYE operation.

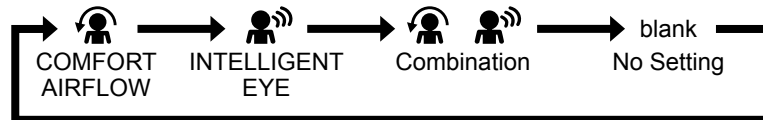

- When the flaps (horizontal blades) are swinging, the operating as above will stop movement of them.

■ To cancel operation

Press  and select “blank” on the LCD.

NOTE

■ Notes on COMFORT AIRFLOW operation

- The flap position will change, preventing air from blowing directly on the occupants of the room.
- POWERFUL operation and COMFORT AIRFLOW operation cannot be used at the same time. Priority is given to the function of whichever button is pressed last.
- The airflow rate will be set to AUTO. If the upper and lower airflow direction is selected, the COMFORT AIRFLOW function will be canceled.

■ Notes on INTELLIGENT EYE operation

- Application range is as follows.

Vertical angle 90°
(Side view)

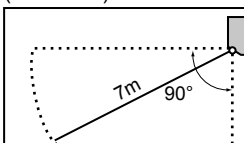

Horizontal angle 110°
(Top view)

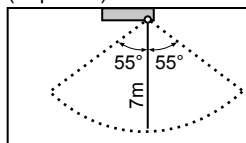

- Sensor may not detect moving objects further than 7m away. (Check the application range)
- Sensor detection sensitivity changes according to indoor unit location, the speed of passersby, temperature range, etc.
- The sensor also mistakenly detects pets, sunlight, fluttering curtains and light reflected off of mirrors as passersby.
- INTELLIGENT EYE operation will not go on during POWERFUL operation.
- NIGHT SET MODE [▶Page 20](#) will not go on during use of INTELLIGENT EYE operation.

■ Notes on combination of COMFORT AIRFLOW operation and INTELLIGENT EYE operation

- The airflow rate will be set to AUTO. If the upper and lower airflow direction is selected, the COMFORT AIRFLOW operation will be canceled. Priority is given to the function of whichever button is pressed last.

CAUTION

- Do not place large objects near the sensor. Also keep heating units or humidifiers outside the sensor's detection area. This sensor can detect undesirable objects.
- Do not hit or violently push the INTELLIGENT EYE sensor. This can lead to damage and malfunction.



POWERFUL Operation

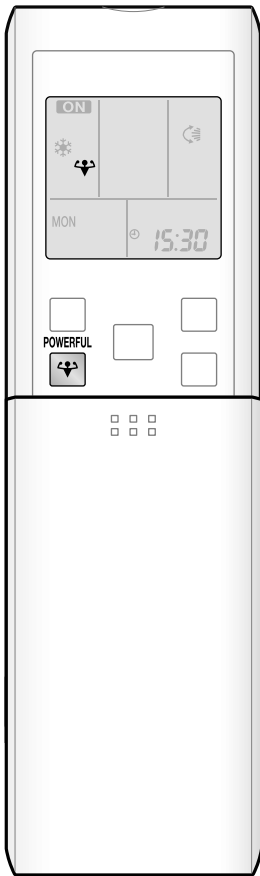

POWERFUL operation quickly maximizes the cooling (heating) effect in any operation mode. You can get the maximum capacity.

■ To start POWERFUL operation

Press  during operation.

- POWERFUL operation ends in 20 minutes. Then the system automatically operates again with the previous settings which were used before POWERFUL operation.
- “” is displayed on the LCD.

■ To cancel POWERFUL operation

Press  again.

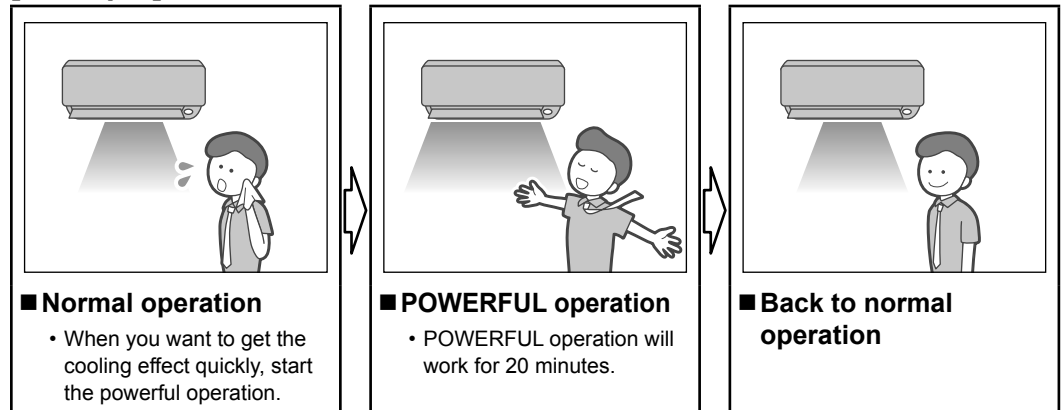

- “” disappears from the LCD.

[Example]



NOTE

■ Notes on POWERFUL operation

- When using POWERFUL operation, there are some functions which are not available.
- POWERFUL operation cannot be used together with ECONO, COMFORT AIRFLOW or OUTDOOR UNIT QUIET operation. Priority is given to the function of whichever button is pressed last.
- POWERFUL operation can only be set when the unit is running. Pressing  causes the settings to be canceled, and the “” disappears from the LCD.
- POWERFUL operation will not increase the capacity of the air conditioner if the air conditioner is already in operation with its maximum capacity demonstrated.
- **In COOL and HEAT mode**
To maximize the cooling (heating) effect, the capacity of outdoor unit must be increased and the airflow rate be fixed to the maximum setting. The temperature and airflow settings are not variable.
- **In DRY mode**
The temperature setting is lowered by 2.5°C and the airflow rate is slightly increased.
- **In FAN mode**
The airflow rate is fixed to the maximum setting.
- **In AUTO mode**
To maximize the cooling (heating) effect, the capacity of outdoor unit must be increased and the airflow rate be fixed to the maximum setting.



OUTDOOR UNIT QUIET Operation

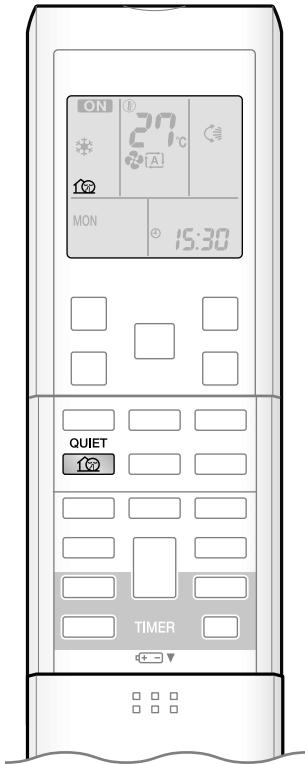

OUTDOOR UNIT QUIET operation lowers the noise level of the outdoor unit by changing the frequency and fan speed on the outdoor unit. This function is convenient during the night.

■ To start OUTDOOR UNIT QUIET operation

Press .

- “” is displayed on the LCD.

■ To cancel OUTDOOR UNIT QUIET operation

Press  again.

- “” disappears from the LCD.

[Example] Using the OUTDOOR UNIT QUIET operation during the night.

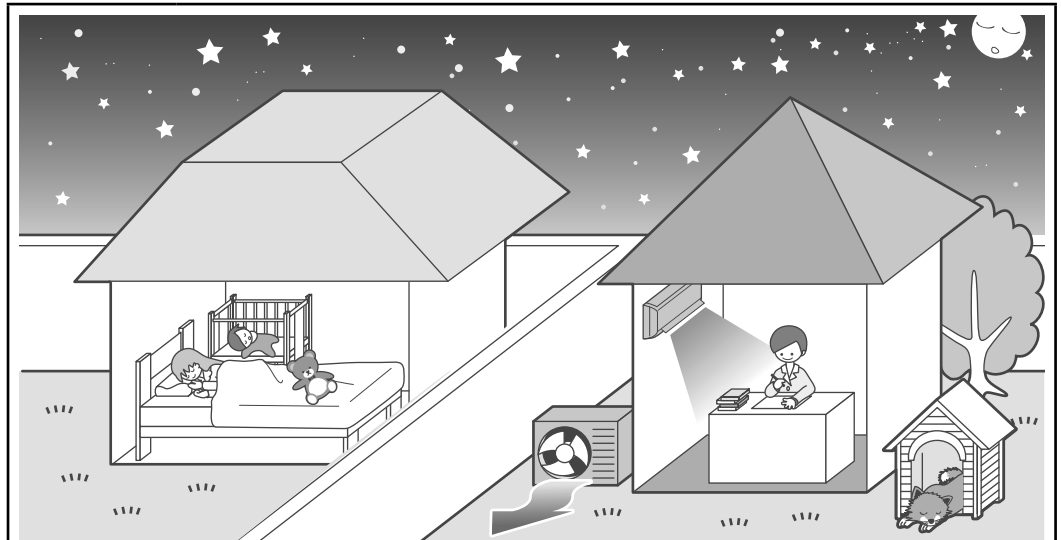

- The noise level of the outdoor unit will be lower.
This is convenient when you need to consider for your neighborhood.

NOTE

■ Notes on OUTDOOR UNIT QUIET operation

- If using a multi system, this function will work only when the OUTDOOR UNIT QUIET operation is set on all operated indoor units. However, if using priority room setting, refer to “Note for multi system”. ▶Page 28
- This function is available in COOL, HEAT, and AUTO mode.
This is not available in FAN and DRY mode.
- POWERFUL operation and OUTDOOR UNIT QUIET operation cannot be used at the same time.
Priority is given to the function of whichever button is pressed last.
- Even the operation is stopped using the remote controller or the main unit ON/OFF switch when using OUTDOOR UNIT QUIET operation, “” will remain on the remote controller display.
- OUTDOOR UNIT QUIET operation will drop neither the frequency nor fan speed if they have been already dropped low enough.



ECONO Operation

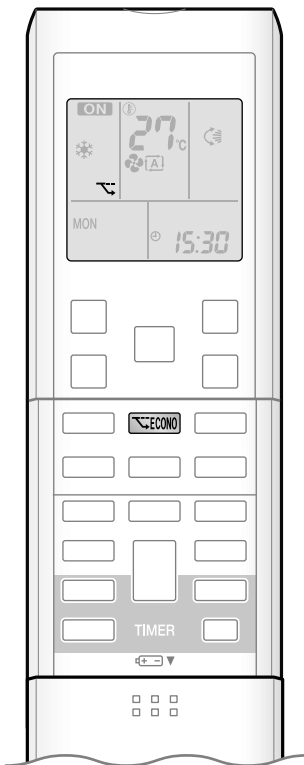

ECONO operation is a function which enables efficient operation by limiting the maximum power consumption value. This function is useful for cases in which attention should be paid to ensure a circuit breaker will not trip when the product runs alongside other appliances.

■ To start ECONO operation

Press during operation.

- “” is displayed on the LCD.

■ To cancel ECONO operation

Press again.

- “” disappears from the LCD.

[Example]

Normal operation



- In case the air conditioner and other appliances which require high power consumption are used at same time, a circuit breaker may trip if the air conditioner operate with its maximum capacity.

ECONO operation

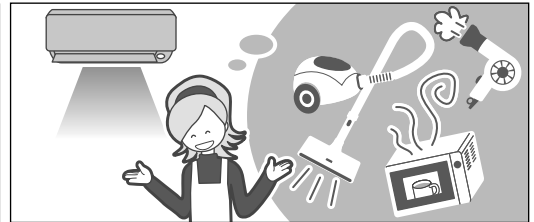

- The maximum power consumption of the air conditioner is limited by using ECONO operation. The circuit breaker will hardly trip even if the air conditioner and other appliances are used at same time.

Running current and power consumption

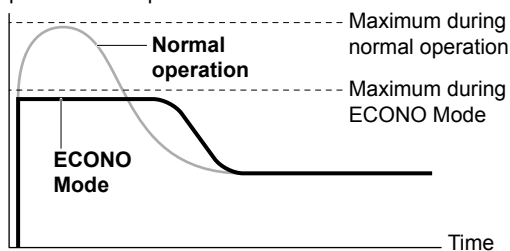

From start up until set temperature is reached

- This diagram is a representation for illustrative purposes only. The maximum running current and power consumption of the air conditioner in ECONO mode vary with the connecting outdoor unit.

NOTE

■ Notes on ECONO operation

- ECONO operation can only be set when the unit is running. Pressing causes the settings to be canceled, and the “” disappears from the LCD.
- ECONO operation is a function which enables efficient operation by limiting the power consumption of the outdoor unit (operating frequency).
- ECONO operation functions in AUTO, COOL, DRY, and HEAT modes.
- POWERFUL and ECONO operation cannot be used at the same time. Priority is given to the function of whichever button is pressed last.
- If the level of power consumption is already low, ECONO operation will not drop the power consumption.



OFF TIMER Operation

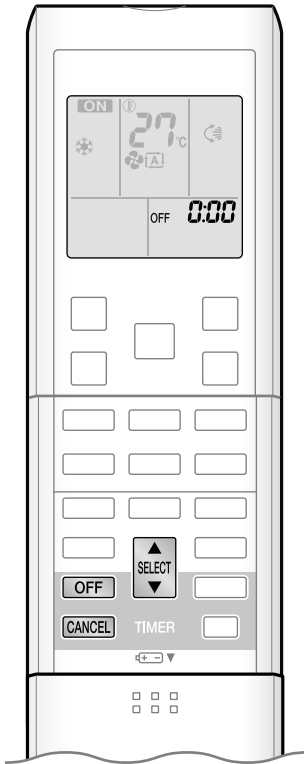

Timer functions are useful for automatically switching the air conditioner on or off at night or in the morning. You can also use OFF TIMER and ON TIMER in combination.

■ To use OFF TIMER operation

- Check that the clock is correct.
If not, set the clock to the present time. ▶Page 10

1. Press **OFF** .

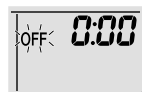

“ 0:00 ” is displayed on the LCD.
“ OFF ” blinks.

- “ ☉ ” and day of the week disappear from the LCD.

2. Press **SELECT** until the time setting reaches the point you like.

- Each pressing of either button increases or decreases the time setting by 10 minutes.
Holding down either button changes the time setting rapidly.

3. Press **OFF** again.

- “ OFF ” and setting time are displayed on the LCD.
- The TIMER lamp lights up.



Display

■ To cancel OFF TIMER operation

Press **CANCEL** .

- “ OFF ” and setting time disappear from the LCD.
- “ ☉ ” and day of the week are displayed on the LCD.
- The TIMER lamp goes off.

NOTE

■ Notes on TIMER operation

- When TIMER is set, the present time is not displayed.
- Once you set ON/OFF TIMER, the time setting is kept in the memory. The memory is canceled when remote controller batteries are replaced.
- When operating the unit via the ON/OFF timer, the actual length of operation may vary from the time entered by the user. (Maximum approx. 10 minutes)

■ NIGHT SET MODE

- When the OFF TIMER is set, the air conditioner automatically adjusts the temperature setting (0.5°C up in COOL, 2.0°C down in HEAT) to prevent excessive cooling (heating) for your pleasant sleep.



ON TIMER Operation

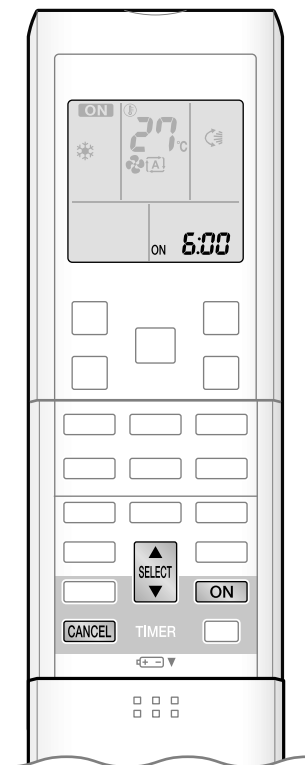

■ To use ON TIMER operation

- Check that the clock is correct.
If not, set the clock to the present time. ▶Page 10

1. Press **ON**.

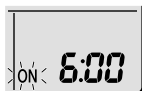

- “6:00” is displayed on the LCD.
- “ON” blinks.

- “⊕” and day of the week disappear from the LCD.

2. Press **SELECT** until the time setting reaches the point you like.

- Each pressing of either button increases or decreases the time setting by 10 minutes.
Holding down either button changes the setting rapidly.

3. Press **ON** again.

- “ON” and setting time are displayed on the LCD.
- The TIMER lamp lights up.



Display

■ To cancel ON TIMER operation

Press **CANCEL**.

- “ON” and setting time disappear from the LCD.
- “⊕” and day of the week are displayed on the LCD.
- The TIMER lamp goes off.

■ To combine ON TIMER and OFF TIMER

- A sample setting for combining the 2 timers is shown below.

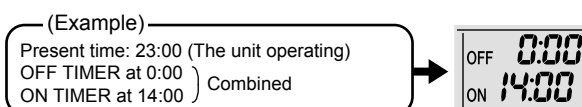

NOTE

■ In the following cases, set the timer again.

- After a breaker has turned off.
- After a power failure.
- After replacing batteries in the remote controller.



WEEKLY TIMER Operation

Up to 4 timer settings can be saved for each day of the week. It is convenient if the WEEKLY TIMER is set according to the family's life style.

Using in these cases of WEEKLY TIMER

Example: The same timer settings are made for the week from Monday through Friday while different timer settings are made for the weekend.

<p>[Monday]</p>	<p>Make timer settings up to programs 1-4. ▶Page 23</p>
<p>[Tuesday to Friday]</p>	<p>Use the copy mode to make settings for Tuesday to Friday, because these settings are the same as those for Monday. ▶Page 25</p>
<p>[Saturday]</p>	<p>No timer settings</p>
<p>[Sunday]</p>	<p>Make timer settings up to programs 1-4. ▶Page 23</p>

- Up to 4 reservations per day and 28 reservations per week can be set in the WEEKLY TIMER. The effective use of the copy mode ensures ease of making reservations.
- The use of ON-ON-ON-ON settings, for example, makes it possible to schedule operating mode and set temperature changes. Furthermore, by using OFF-OFF-OFF-OFF settings, only the turn off time of each day can be set. This will turn off the air conditioner automatically if the user forgets to turn it off.



WEEKLY TIMER Operation

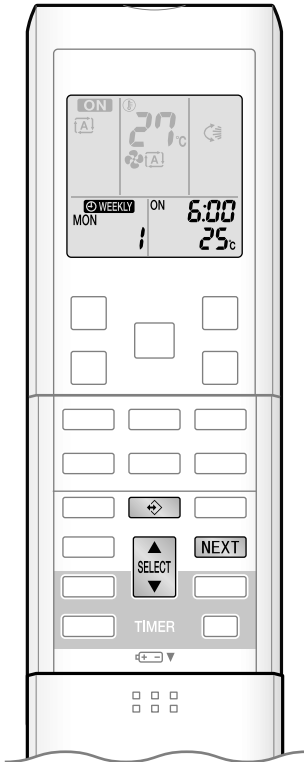

■ To use WEEKLY TIMER operation

Setting mode

- Make sure the day of the week and time are set. If not, set the day of the week and time.

▶ Page 10

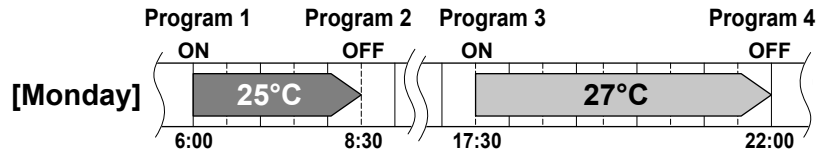

Setting Displays

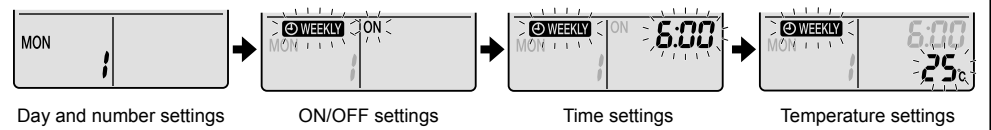

1. Press .

- The day of the week and the reservation number of the current day will be displayed.
- 1 to 4 settings can be made per day.

2. Press to select the desired day of the week and reservation number.

- Pressing  changes the reservation number and the day of the week.

3. Press .

- The day of the week and reservation number will be set.
- “ WEEKLY” and “ON” blink.

4. Press to select the desired mode.

- Pressing  changes “ON” or “OFF” setting in sequence.

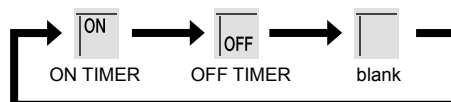

- In case the reservation has already been set, selecting “blank” deletes the reservation.
- Go to **STEP 9** if “blank” is selected.

5. Press .

- The ON/OFF TIMER mode will be set.
- “ WEEKLY” and the time blink.

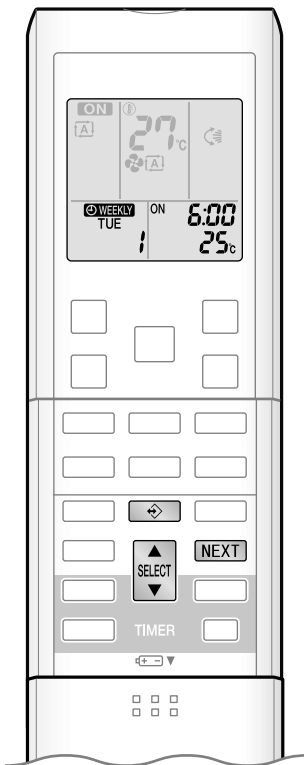

6. Press to select the desired time.

- The time can be set between 0:00 and 23:50 in 10 minute intervals.
- To return to the ON/OFF TIMER mode setting, press **BACK**.
- Go to **STEP 9** when setting the OFF TIMER.

7. Press .

- The time will be set.
- “**WEEKLY**” and the temperature blink.

8. Press to select the desired temperature.

- The temperature can be set between 10°C and 32°C.
Cooling: The unit operates at 18°C even if it is set at 10 to 17°C.
Heating: The unit operates at 30°C even if it is set at 31 to 32°C.
- To return to the time setting, press **BACK**.
- The set temperature is only displayed when the mode setting is on.

9. Press .

- The temperature will be set and go to the next reservation setting.
- To continue further settings, repeat the procedure from **STEP 4**.

10. Press to complete the setting.

- Be sure to direct the remote controller toward the indoor unit and check for a receiving tone and flashing the operation lamp.
- “**WEEKLY**” is displayed on the LCD and WEEKLY TIMER operation is activated.
- The TIMER lamp lights up.





Display

- A reservation made once can be easily copied and the same settings used for another day of the week. Refer to **Copy mode** . 

NOTE

■ Notes on WEEKLY TIMER operation

- Do not forget to set the clock on the remote controller first. 
- The day of the week, ON/OFF TIMER mode, time and set temperature (only for ON TIMER mode) can be set with WEEKLY TIMER. Other settings for ON TIMER are based on the settings just before the operation.
- Both WEEKLY TIMER and ON/OFF TIMER operation cannot be used at the same time. The ON/OFF TIMER operation has priority if it is set while WEEKLY TIMER is still active. The WEEKLY TIMER will go into standby state, and “**WEEKLY**” will disappear from the LCD. When ON/OFF TIMER is up, the WEEKLY TIMER will automatically become active.
- Only the time and set temperature set with the WEEKLY TIMER are sent with the . Set the WEEKLY TIMER only after setting the operation mode, the airflow rate and the airflow direction ahead of time.
- Shutting the breaker off, power failure, and other similar events will render operation of the indoor unit's internal clock inaccurate. Reset the clock. 
- The **BACK** can be used only for the time and temperature settings. It cannot be used to go back to the reservation number.



WEEKLY TIMER Operation

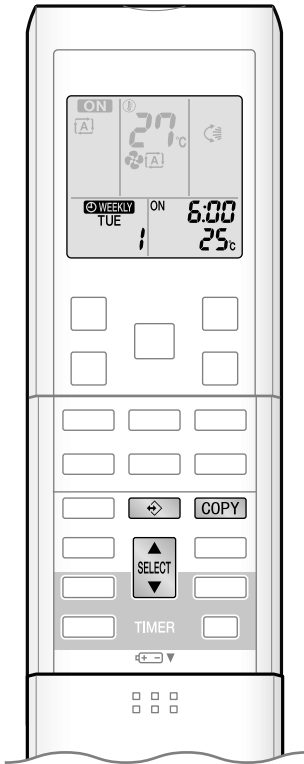

Copy mode

- A reservation made once can be copied to another day of the week. The whole reservation of the selected day of the week will be copied.

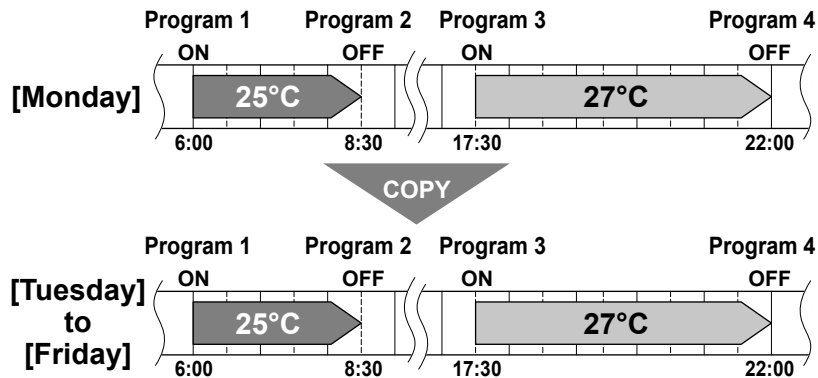

Setting Displays

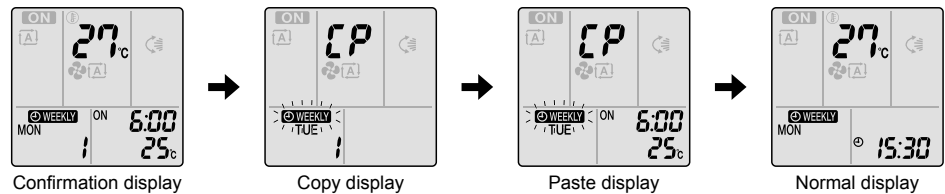

1. Press .
2. Press SELECT to confirm the day of the week to be copied.
3. Press .
 - The whole reservation of the selected day of the week will be copied.
4. Press SELECT to select the destination day of the week.
5. Press .
 - The reservation will be copied to the selected day of the week. The whole reservation of the selected day of the week will be copied.
 - To continue copying the settings to other days of the week, repeat **STEP 4** and **STEP 5**.
6. Press to complete the setting.
 - “ WEEKLY” is displayed on the LCD and WEEKLY TIMER operation is activated.

NOTE

■ Note on COPY MODE

- The entire reservation of the source day of the week is copied in the copy mode.

In the case of making a reservation change for any day of the week individually after copying the content of weekly reservations, press

and change the settings in the steps of **Setting mode** . Page 23

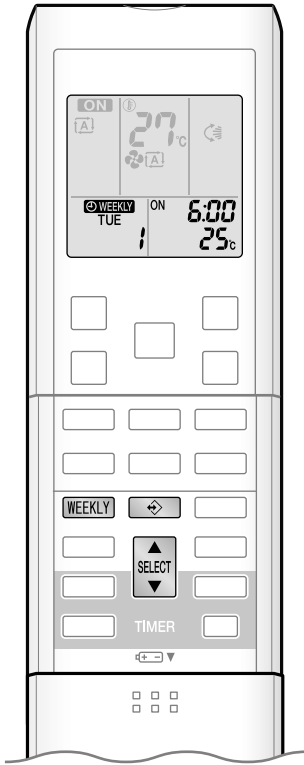

■ Confirming a reservation

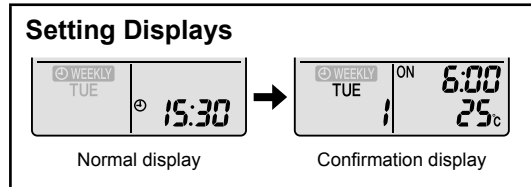

- The reservation can be confirmed.



1. Press .

- The day of the week and the reservation number of the current day will be displayed.

2. Press to select the day of the week and the reservation number to be confirmed.

- Pressing  displays the reservation details.
- To change the confirmed reserved settings, select the reservation number and press **NEXT**.
- The mode is switched to setting mode. Go to **Setting mode** STEP 4. 

3. Press to exit confirming mode.

- “**WEEKLY**” is displayed on the LCD and WEEKLY TIMER operation is activated.
- The TIMER lamp lights up.



Display

■ To deactivate WEEKLY TIMER operation

Press **WEEKLY** while “**WEEKLY**” is displayed on the LCD.

- The “**WEEKLY**” will disappear from the LCD.
- The TIMER lamp goes off.
- To reactivate the WEEKLY TIMER operation, press **WEEKLY** again.
- If a reservation deactivated with **WEEKLY** is activated once again, the last reservation mode will be used.



WEEKLY TIMER Operation

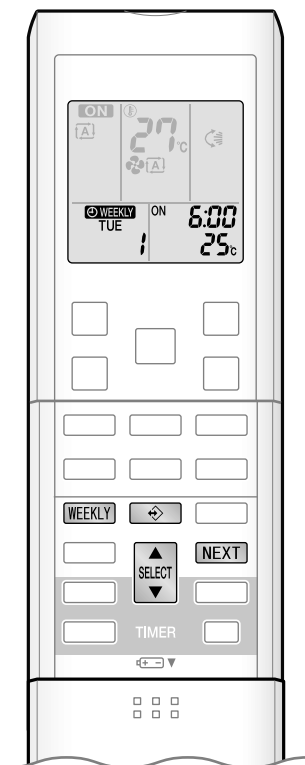

■ To delete reservations

The individual reservation

1. Press

- The day of the week and the reservation number will be displayed.

2. Press to select the day of the week and the reservation number to be deleted.

3. Press

- “ WEEKLY” and “ON” or “OFF” blink.

4. Press and select “blank”.

- Pressing changes ON/OFF TIMER mode.

- The reservation will be no setting with selecting “blank”.

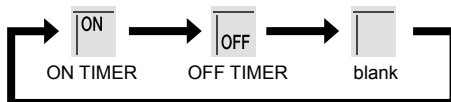

5. Press

- The selected reservation will be deleted.

6. Press

- If there are still other reservations, WEEKLY TIMER operation will be activated.

The reservations for each day of the week

- This function can be used for deleting reservations for each day of the week.
- It can be used while confirming or setting reservations.

1. Press to select the day of the week to be deleted.

2. Hold for 5 seconds.

- The reservation of the selected day of the week will be deleted.

All reservations

Hold for 5 seconds while normal display.

- Be sure to direct the remote controller toward the indoor unit and check for a receiving tone.
- This operation is not effective while WEEKLY TIMER is being set.
- All reservations will be deleted.

Note for Multi System

Multi system has one outdoor unit connected to multiple indoor units.

■ Selecting the operation mode

With the priority room setting present but inactive or not present.

When more than one indoor unit is operating, priority is given to the first unit that was turned on.

In this case, set the units that are turned on later to the same operation mode as the first unit.

Otherwise, they will enter the standby state, and the operation lamp will flash: this does not indicate malfunction.

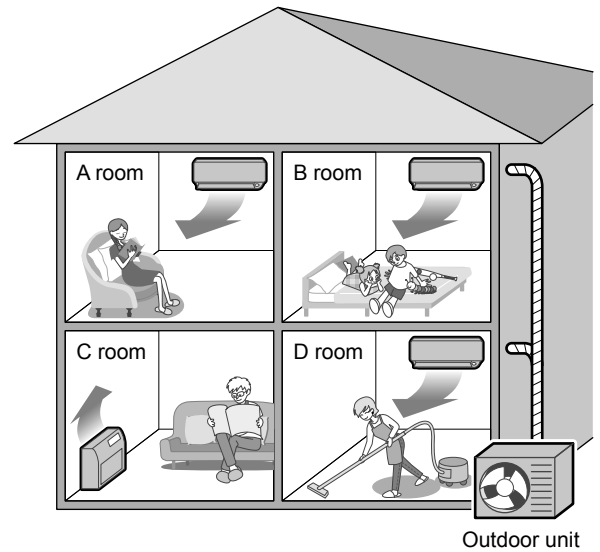

NOTE

■ Notes on operation mode for multi system

- COOL, DRY and FAN mode may be used at the same time.
- AUTO mode automatically selects COOL mode or HEAT mode based on the room temperature. Therefore, AUTO mode is available when selecting the same operation mode as that of the room with the first unit to be turned on.

⚠ CAUTION

- Normally, the operation mode in the room where the unit is first run is given priority, but the following situations are exceptions, so please keep this in mind.

If the operation mode of the first room is **FAN mode**, then using **HEAT mode** in any room after this will give priority to **HEAT**. In this situation, the air conditioner running in FAN mode will go on standby, and the operation lamp will flash.

With the priority room setting active.

Refer to “**Priority room setting**” on the next page.

■ NIGHT QUIET mode (Available only for COOL operation)

NIGHT QUIET mode requires initial programming during installation. Please consult your retailer or dealer for assistance. NIGHT QUIET mode reduces the operation noise of the outdoor unit during the nighttime hours to prevent annoyance to neighbors.

- The NIGHT QUIET mode is activated when the temperature drops 5°C or more below the highest temperature recorded that day. Therefore, when the temperature difference is less than 5°C, this function will not be activated.
- NIGHT QUIET mode reduces slightly the cooling efficiency of the unit.

■ OUTDOOR UNIT QUIET operation

Refer to “**OUTDOOR UNIT QUIET operation**”. ▶Page 18

With the priority room setting present but inactive or not present.

When using the OUTDOOR UNIT QUIET operation feature with the Multi system, set all indoor units to OUTDOOR UNIT QUIET operation using their remote controllers.

When clearing OUTDOOR UNIT QUIET operation, clear one of the operating indoor units using their remote controller.

However OUTDOOR UNIT QUIET operation display remains on the remote controller for other rooms.

We recommend you release all rooms using their remote controllers.

With the priority room setting active.

Refer to “**Priority room setting**” on the next page.

Note for Multi System

■ COOL / HEAT mode lock

The COOL / HEAT mode lock requires initial programming during installation. Please consult your authorized dealer for assistance. The COOL / HEAT mode lock sets the unit forcibly to either COOL or HEAT mode. This function is convenient when you wish to set all indoor units connected to the multi system to the same operation mode.

■ Priority room setting

The priority room setting requires initial programming during installation. Please consult your authorized dealer for assistance. The room designated as the priority room takes priority in the following situations.

Operation mode priority

- As the operation mode of the priority room takes precedence, the user can select a different operation mode from other rooms.

[Example]

- Room A is the priority room in the examples.
When COOL mode is selected in room A while operating the following modes in room B, C and D :

Operation mode in room B, C and D	Status of room B, C and D when the unit in room A is in COOL mode
COOL or DRY or FAN	Current operation mode maintained
HEAT	The unit enters standby mode. Operation resumes when the room A unit stops operating.
AUTO	If the unit is set to COOL mode, operation continues. If the unit is set to HEAT mode, it enters standby mode. Operation resumes when the room A unit stops operating.

Priority when POWERFUL operation is used

[Example]

- Room A is the priority room in the examples.
The indoor units in rooms A, B, C and D are all operating. If the unit in room A enters POWERFUL operation, operation capacity will be concentrated in room A. In such a case, the COOL (HEAT) efficiency of the units in room B, C and D may be slightly reduced.

Priority when using OUTDOOR UNIT QUIET operation

[Example]

- Room A is the priority room in the examples.
Just by setting the unit in room A to QUIET operation, the air conditioner starts OUTDOOR UNIT QUIET operation. You don't have to set all the operated indoor units to QUIET operation.

Care and Cleaning

■ Quick reference

How to open / close the front panel

- Hold the front panel by the panel tabs on the 2 sides and open it.
- Press the front panel at both sides and the center to close it.

Cleaning parts

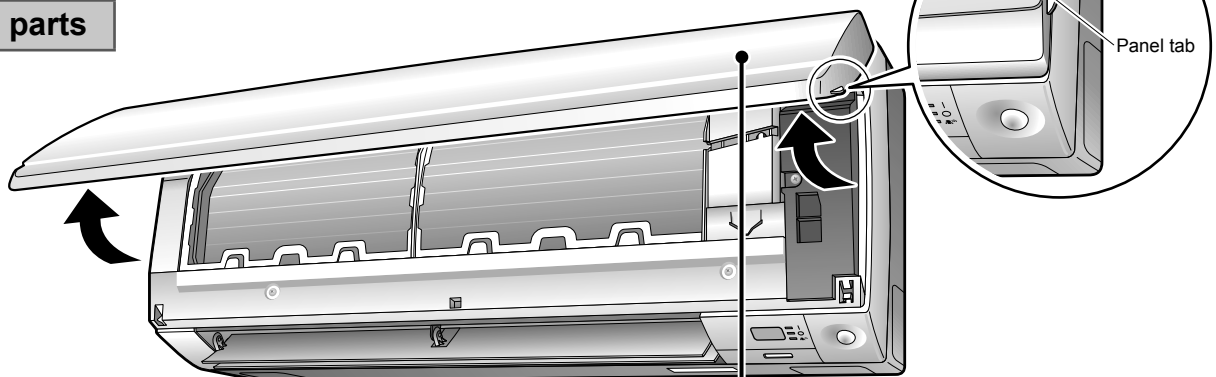

Air filter

- Vacuum dust or wash filter.

Once every 2 weeks

Refer to ▶Page 32

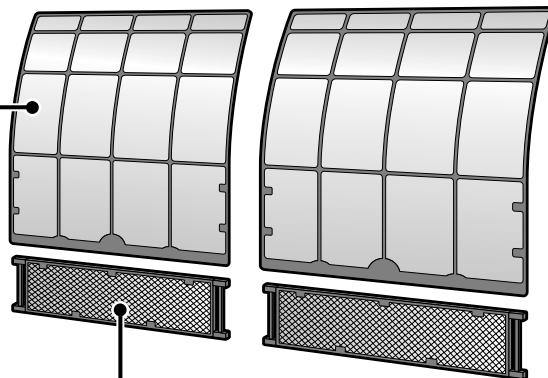

Front panel

- Wipe it with dry soft cloth.

If bothered by dirt

Refer to ▶Page 31

Titanium apatite photocatalytic air-purifying filter

- Vacuum dust or replace the filter.

[Cleaning]

Once every 6 months

Refer to ▶Page 33

[Replacement]

Once every 3 years

Refer to ▶Page 33

Indoor unit, Outdoor unit and Remote controller

- Wipe them with soft cloth.

If bothered by dirt

Notes on cleaning

■ For cleaning, do not use the materials as follows.

- Hot water above 40°C.
- Benzine, gasoline, thinner, other volatile oils.
- Polishing compound.
- Scrubbing brushes, other hard stuff.



⚠ CAUTION

- Before cleaning, be sure to stop the operation and turn the breaker off.
- Do not touch the metal parts of the indoor unit. If you touch those parts, this may cause an injury.

Care and Cleaning

■ Front panel

1. Remove the front panel.

- Open the front panel.
- Slide the front panel to either the left or right and pulling it toward you. This will disconnect the rotation dowel on one side.

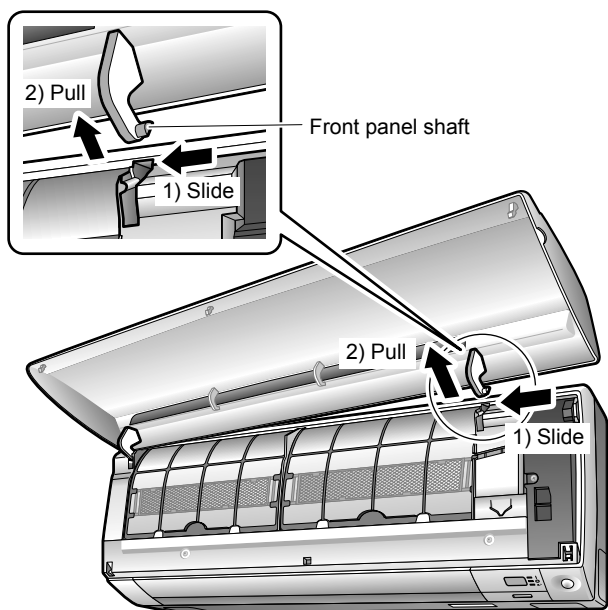

- Disconnect the front panel shaft on the other side in the same manner.

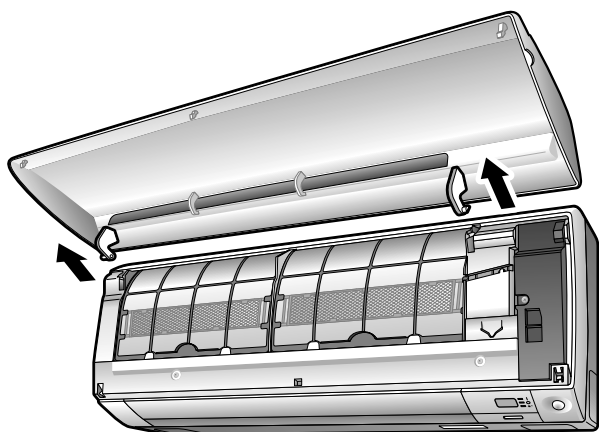

2. Clean the front panel.

- Wipe it with a soft cloth soaked in water.
- Only neutral detergent may be used.
- In case of washing the panel with water, wipe it with dry soft cloth, dry it up in the shade after washing.

3. Attach the front panel.

- Align the front panel shaft on the left and right of the front panel with the slots, then push them all the way in.

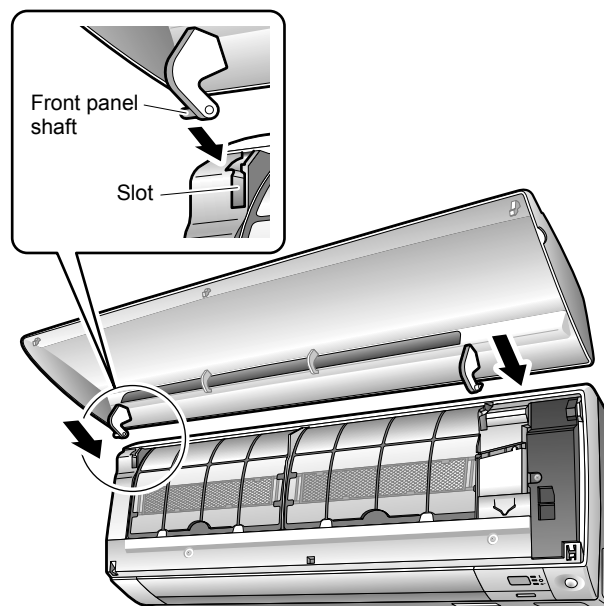

- Close the front panel slowly. (Press the panel at both sides and the center.)

⚠ CAUTION

- When removing or attaching the front panel, use a robust and stable stool and watch your steps carefully.
- When removing or attaching the front panel, support the panel securely with hand to prevent it from falling.
- After cleaning, make sure that the front panel is securely fixed.

■ Air filter

1. Pull out the air filters.

- Open the front panel.
- Push a little upwards the filter tab at the center of each air filter, then pull it down.

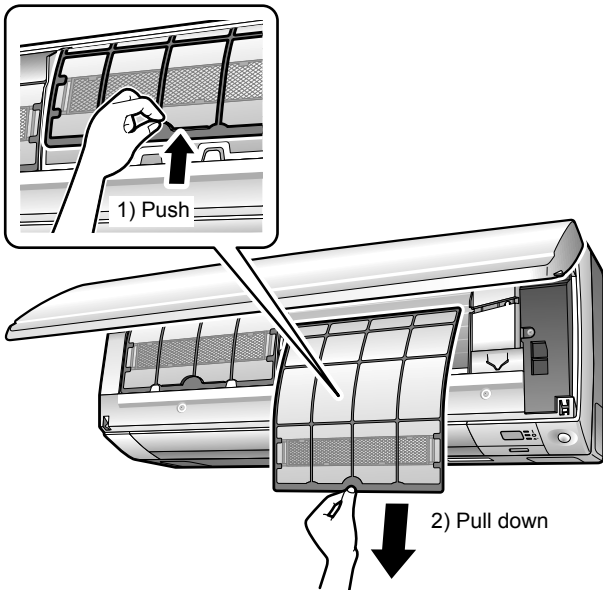

2. Wash the air filters with water or clean them with vacuum cleaner.

- It is recommended to clean the air filters every 2 weeks.

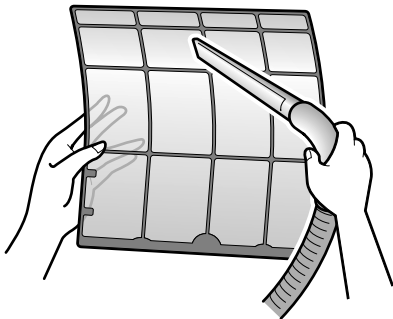

If the dust does not come off easily

- Wash the air filters with neutral detergent thinned with lukewarm water, then dry them up in the shade.
- Be sure to remove the titanium apatite photocatalytic air-purifying filter. Refer to "Titanium apatite photocatalytic air-purifying filter" on the next page.

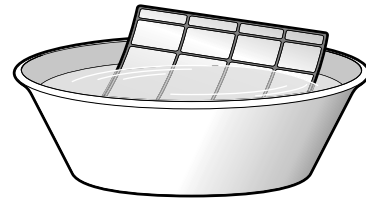

3. Set the filters as they were and close the front panel.

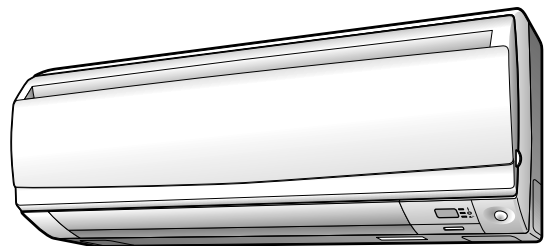

⚠ CAUTION

- Do not touch the aluminum fins by bare hand at the time of dismounting or mounting the filter.

Care and Cleaning

■ Titanium apatite photocatalytic air-purifying filter

1. Take off the titanium apatite photocatalytic air-purifying filter.

- Open the front panel and pull out the air filters.
- Hold the recessed parts of the frame and unhook the 4 claws.

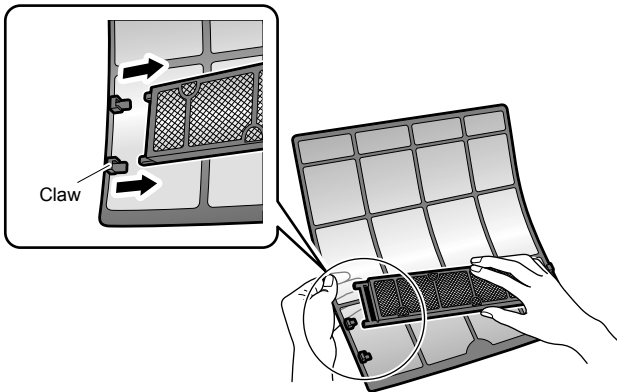

2. Clean or replace the titanium apatite photocatalytic air-purifying filter.

[Maintenance]

2-1 Vacuum dusts, and soak in lukewarm water or water for about 10 to 15 minutes if dirt is heavy.

- Do not remove the filter from frame when washing with water.

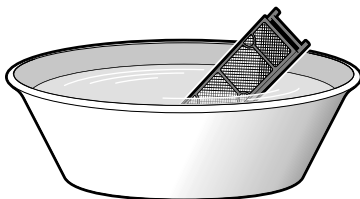

2-2 After washing, shake off remaining water and dry in the shade.

- Since the material is made out of polyester, do not wring out the filter when removing water from it.

[Replacement]

Remove the tabs on the filter frame and replace with a new filter.

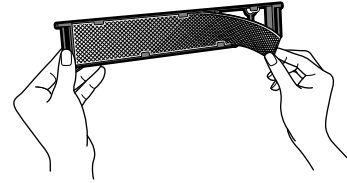

- Do not throw away the filter frame. Reuse the filter frame when replacing the titanium apatite photocatalytic air-purifying filter.
- Dispose of the old filter as non-flammable waste.

3. Set the filters as they were and close the front panel.

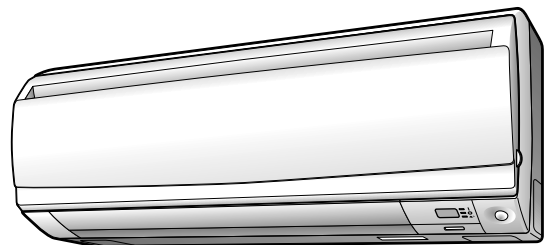

NOTE

- Operation with dirty filters:
 - cannot deodorize the air,
 - cannot clean the air,
 - results in poor heating or cooling,
 - may cause odour,
- Dispose of old filters as non-flammable waste.
- To order titanium apatite photocatalytic air-purifying filter contact to the service shop there you bought the air conditioner.



Item	Titanium apatite photocatalytic air-purifying filter (without frame) 1 set
Part No.	KAF970A46

■ Check the units

- Check that the base, stand and other fittings of the outdoor unit are not decayed or corroded.
 - Check that nothing blocks the air inlets and the outlets of the indoor unit and the outdoor unit.
 - Check that the drain comes smoothly out of the drain hose during COOL or DRY operation.
 - If no drain water is seen, water may be leaking from the indoor unit. Stop operation and consult the service shop if this is the case.
-

■ Before a long idle period

1. Operate the “FAN only” for several hours on a fine day to dry out the inside.

- Press **MODE** and select “” operation.
- Press  and start operation.

2. After operation stops, turn off the breaker for the room air conditioner.

3. Clean the air filters and set them again.

4. Take out batteries from the remote controller.

- When a multi outdoor unit is connected, make sure the heating operation is not used at the other room before you use the fan operation. [▶Page 28](#)

Troubleshooting

■ These cases are not troubles.

- The following cases are not air conditioner troubles but have some reasons. You may just continue using it.

Indoor unit

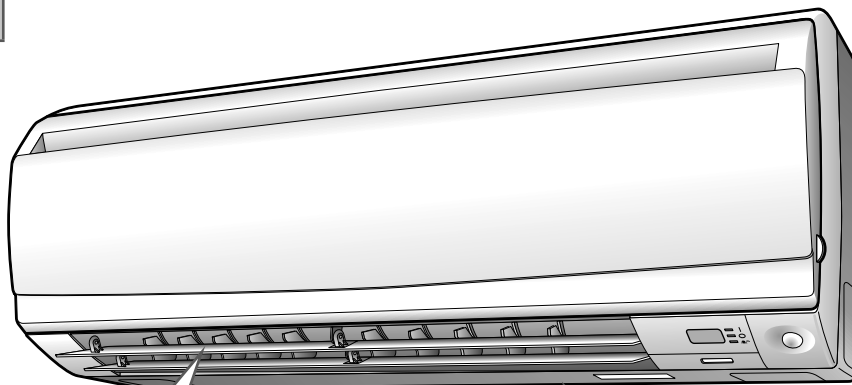

The flaps does not start swing immediately.

- The air conditioner is adjusting the flap position. The flap will start moving soon.

The heating operation stops suddenly and a flowing sound is heard.

- The system is taking away the frost on the outdoor unit. You should wait for about 4 to 12 minutes.

Operation does not start soon.

- **When ON/OFF button was pressed soon after operation was stopped.**
- **When the mode was reselected.**
 - This is to protect the air conditioner. You should wait for about 3 minutes.

A sound is heard.

■ A sound like a flow of water

- This sound is generated because the refrigerant in the air conditioner is flowing.
- This is a pumping sound of the water in the air conditioner and heard when the water is pumped out from the air conditioner in cooling or drying operation.
- The refrigerant flows in the air conditioner even if the air conditioner is not working when the indoor units in other rooms are in operation.

■ Blowing sound

- This sound is generated when the flow of the refrigerant in the air conditioner is switched over.

■ Pinging sound

- This sound is generated when the size of the air conditioner slightly expands or shrinks as a result of temperature changes.

Outdoor unit

The outdoor unit emits water or steam.

■ In HEAT mode

- The frost on the outdoor unit melts into water or steam when the air conditioner is in defrost operation.

■ In COOL or DRY mode

- Moisture in the air condenses into water on the cool surface of outdoor unit piping and drips.

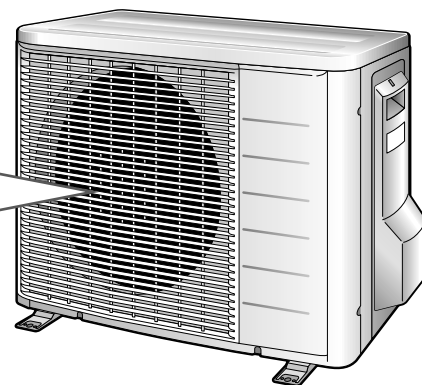

- Troubleshooting measures are classified into the following two types on a remedial basis. Take an appropriate measure according to the symptom.



Not trouble

- These cases are not troubles.



Check

- Please check again before calling a repair person.

The air conditioner does not operate. (OPERATION lamp is off.)

- Hasn't a breaker turned off or a fuse blown?
- Isn't it a power failure?
- Are batteries set in the remote controller?
- Is the timer setting correct?



Hot air does not flow out soon after the start of heating operation.

- The air conditioner is warming up. You should wait for 1 to 4 minutes. (The system is designed to start discharging air only after it has reached a certain temperature.)



Operation stopped suddenly. (OPERATION lamp is on.)

- For system protection, the air conditioner may stop operating on a sudden large voltage fluctuation. It automatically resumes operation in about 3 minutes.



Operation stopped suddenly. (OPERATION lamp flashes.)

- Are the air filters clean?
- Is there anything to block the air inlet or the outlet of the indoor and the outdoor units?
- Clean the air filters or take all obstacles away and turn the breaker off. Then turn it on again and try operating the air conditioner with the remote controller. If the lamp still flashes, call the service shop where you bought the air conditioner.
- Are operation modes all the same for indoor units connected to outdoor units in the **multi system**?
If not, set all indoor units to the same operation mode and confirm that the lamps flash.
Moreover, when the operation mode is in "AUTO", set all indoor unit operation modes to "COOL" or "HEAT" for a moment and check again that the lamps are normal. If the lamps stop flashing after the above steps, there is no malfunction. ▶Page 28



Mist comes out of the indoor unit.

- This happens when the air in the room is cooled into mist by the cold airflow during COOL operation.
- This is because the air in the room is cooled by the heat exchanger and becomes mist during defrost operation.



Troubleshooting

Cooling (Heating) effect is poor.

- Are the air filters clean?
- Is there anything to block the air inlet or the outlet of the indoor and the outdoor units?
- Is the temperature setting appropriate?
- Are the windows and doors closed?
- Are the airflow rate and the airflow direction set appropriately?



Remote controller does not work properly.

- **No remote controller signals are displayed.**
- **The remote controller sensitivity is low.**
- **The display is low in contrast or blacked out.**
- **The display runs out of control.**
 - The batteries are dying and the remote controller is malfunctioning. Replace all the batteries with new, size AAA.LR03 (alkaline). For details, refer to "To set the batteries" of this manual. ▶Page 9



Heating cannot be selected, even though the unit is heat pump model.

- Slide the DIP switch to the left as shown in the illustration so that the heating mode can be selected with the mode selector button.

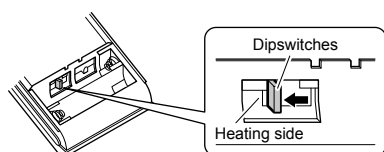

The ON/OFF TIMER does not operate according to the settings.

- Check if the ON/OFF TIMER and the WEEKLY TIMER are set to the same time. Change or deactivate the settings in the WEEKLY TIMER. ▶Page 22



The indoor unit gives out odour.

- This happens when smells of the room, furniture, or cigarettes are absorbed into the unit and discharged with the airflow. (If this happens, we recommend you to have the indoor unit washed by a technician. Consult the service shop where you bought the air conditioner.)



The outdoor fan rotates while the air conditioner is not in operation.

- **After operation is stopped**
 - The outdoor fan continues rotating for another 60 seconds for system protection.
- **While the air conditioner is not in operation**
 - When the outdoor temperature is very high, the outdoor fan starts rotating for system protection.



An abnormal functioning happens during operation.

- The air conditioner may malfunction with lightning or radio waves. Turn the breaker off, turn it on again and try operating the air conditioner with the remote controller.



■ Call the service shop immediately

WARNING

■ When an abnormality (such as a burning smell) occurs, stop operation and turn the breaker off.

- Continued operation in an abnormal condition may result in troubles, electric shocks or fire.
- Consult the service shop where you bought the air conditioner.

■ Do not attempt to repair or modify the air conditioner by yourself.

- Incorrect work may result in electric shocks or fire.
- Consult the service shop where you bought the air conditioner.

If one of the following symptoms takes place, call the service shop immediately.

- The power cord is abnormally hot or damaged.
- An abnormal sound is heard during operation.
- The safety breaker, a fuse, or the earth leakage breaker cuts off the operation frequently.
- A switch or a button often fails to work properly.
- There is a burning smell.
- Water leaks from the indoor unit.

Turn the breaker off and call the service shop.



■ After a power failure

- The air conditioner automatically resumes operation in about 3 minutes. You should just wait for a while.

■ Lightning

- If lightning may strike the neighbouring area, stop operation and turn the breaker off for system protection.

■ Disposal requirements

- Dismantling of the unit, treatment of the refrigerant, oil and eventual other parts, should be done in accordance with the relevant local and national regulations.

■ We recommend periodical maintenance

- In certain operating conditions, the inside of the air conditioner may get foul after several seasons of use, resulting in poor performance. It is recommended to have periodical maintenance by a specialist aside from regular cleaning by the user.
- For specialist maintenance, contact the service shop where you bought the air conditioner.
- The maintenance cost must be born by the user.

Quick Reference

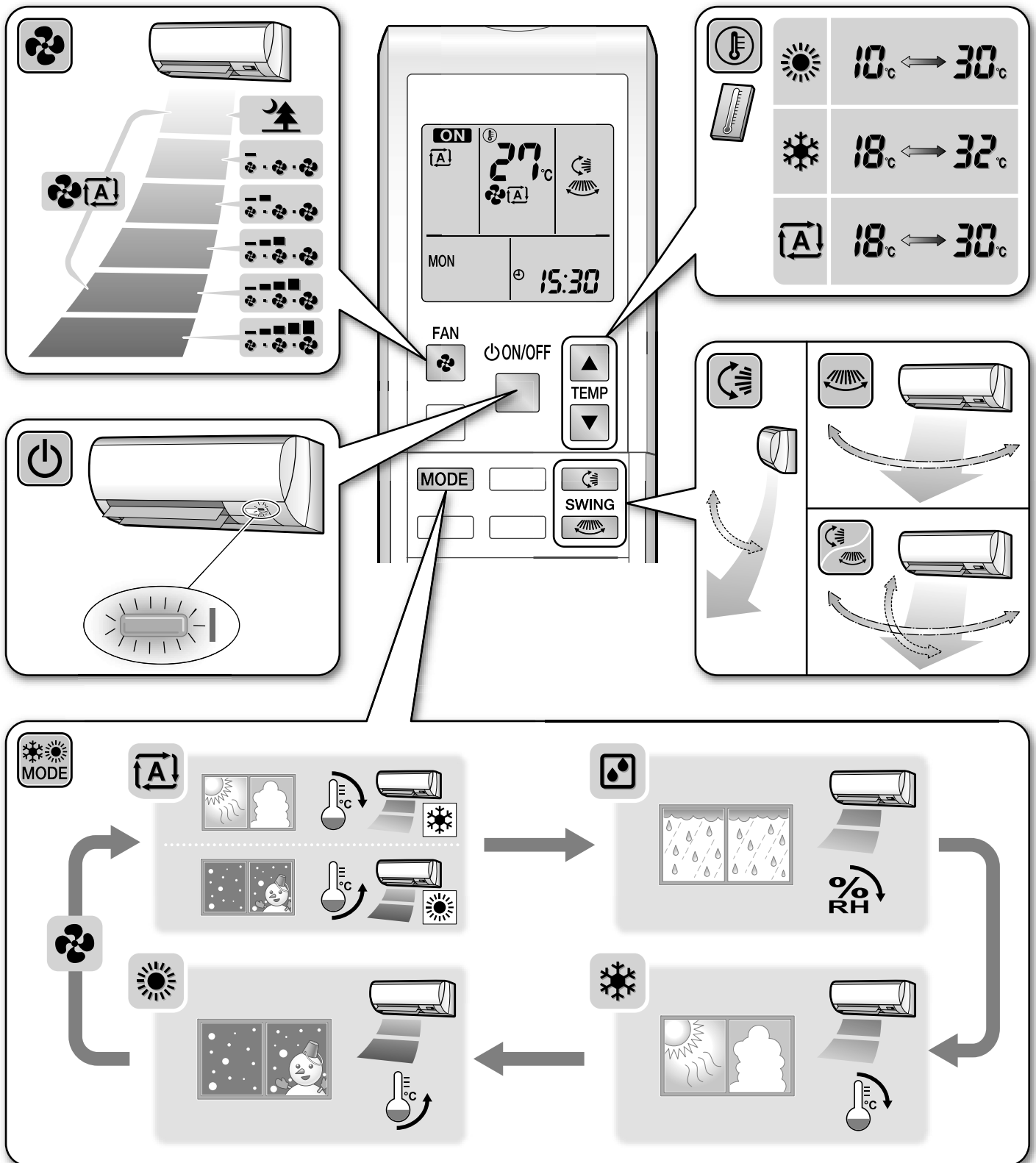

DAIKIN INDUSTRIES, LTD.

Head office:
 Umeda Center Bldg., 2-4-12, Nakazaki-Nishi,
 Kita-ku, Osaka, 530-8323 Japan

Tokyo office:
 JR Shinagawa East Bldg., 2-18-1, Konan,
 Minato-ku, Tokyo, 108-0075 Japan
http://www.daikin.com/global_ac/



Two-dimensional bar code is a code for manufacturing.

3P248412-1 M08B287 (0907) HT